

User's Manual

Condensing Combi-Boilers

Model | VC 100 (LP) COMBI
VC 120 (LP) COMBI
VC 140 (LP) COMBI

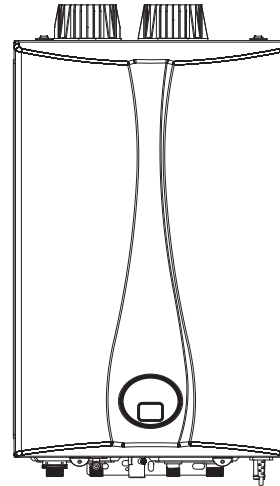

Keep this manual near this boiler for future reference whenever maintenance or service is required.

WARNING

If the information in these instructions is not followed exactly, a fire or explosion may result, causing property damage, personal injury or death.

Do not store or use gasoline or other flammable vapors and liquids in the vicinity of this or any other appliance.

What to do if you smell gas

- Do not try to light any appliance.
- Do not touch any electrical switch.
- Do not use any phone in your building.
- Immediately call your gas supplier from a neighbor's phone. Follow the gas supplier's instructions.
- If you cannot reach your gas supplier, call the fire department.



Installation and service must be performed by a qualified installer, service agency or the gas supplier. The installation must conform with local codes or, in the absence of local codes, the National Fuel Gas Code, ANSI Z223.1/NFPA 54 and/or CSA B149.1, Natural Gas and Propane Installation Code.

Contents







1. Safety Information	3
2. About the Boiler	6
2.1 Names of Components	6
2.2 The Front panel	7
3. Operating the Boiler	8
3.1 Turning the Boiler On or Off	8
3.2 Adjusting the CH temperature	8
4. Maintaining the Boiler	10
4.1 How to clean the hot water filter	10
4.2 How to clean the heating filter	11
4.3 How to supply the water	12
4.4 Maintenance Schedules	13
5. Troubleshooting	21
5.1 Check points before making repair work order	21
5.2 Displayed error code	22

1. Safety Information

- The cautions issued by this user's manual include critical information for the safety while using the product. When the user fails to adhere to the following requirements can cause death, serious damages, and a great property loss.
- For safety, according to the level of danger, we have indicated by "DANGER", "WARNING", "CAUTION" and the definitions for these terms are as follow

 DANGER	When the required terms are not followed, it indicates an urgent danger that may cause death or serious bodily injury
 WARNING	When the required terms are not followed, it indicates latent danger that may cause death or serious bodily injury
 CAUTION	When the required are not followed, it indicates latent danger that may cause light injury or semi-serious injuries

- The definitions of the symbols indicated on the product and user's manual are as follows

	This symbol indicates a "Must" follow sign
	This symbol indicates a "No touch allowed" sign
	This symbol indicates a "General prohibition" sign.
	This symbol indicates a "No Fire" sign
	This symbol indicates "Grounding for prevention of electric shock"
	This symbol indicates "Caution for electric shock"

WARNING

If you do not follow these instructions exactly, a fire or explosion may result causing property damage, personal injury or loss of life.

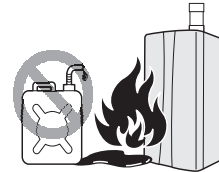

- This appliance does not have a pilot. It is equipped with an ignition device which automatically lights the burner. Do not try to light the burner by hand.
- BEFORE OPERATING smell all around the appliance area for gas. Be sure to smell next to the floor because some gas is heavier than air and will settle on the floor.

WHAT TO DO IF YOU SMELL GAS

- Do not try to light any appliance.
- Do not touch any electric switch; do not use any phone in your building.
- Immediately call your gas supplier from a neighbor's phone. Follow the gas supplier's instructions.
- If you cannot reach your gas supplier, call the fire department.
- Do not return to your home until authorized by your gas supplier or the fire department.
- Use only your hand to push in or turn the gas control knob. Never use tools. If the knob will not push in or turn by hand, don't try to repair it, call a qualified service technician. Force or attempted repair may result in a fire or explosion.
- Do not use this appliance if any part has been under water. Immediately call a qualified service technician to inspect the appliance and to replace any part of the control system and any gas control which has been under water.

! DANGER



To prevent burns:

- Use the lowest operating temperature setting necessary to provide comfortably-hot water.
- If your household has children or elderly or disabled residents, consider using a lower temperature setting.
- Read all the instructions in this manual carefully before changing the temperature setting.
- Feel the water before using it on children, the elderly, or the disabled.
- If it is necessary to set the water temperature above 120 F (49 C), consider installing a thermostatically-controlled mixing valve or temperature-limiting valve. Contact a licensed plumber or your local plumbing authority for more information.

! DANGER

This boiler's water temperature is set to 120 F (49 C) at the factory for your safety and comfort. Increasing the temperature increases the risk of accidental scalding. Water temperatures at or above 125 F (52 C) can cause instant scalding, severe burns, or death. Before you decide to change the temperature setting, read the following charts carefully.

Water Temperature	Time in which a young child can suffer a full thickness (3rd degree) burn
160 F (70 C)	Less than 1 second
140 F (60 C)	1 second
130 F (55 C)	10 seconds
120 F (49 C)	10 minutes
100 F (37 C)	very low scald risk

! WARNING

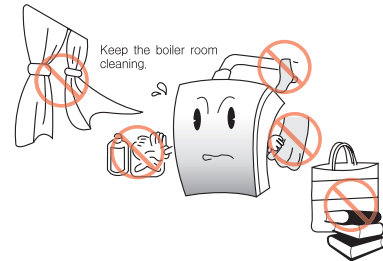

- Shut off the gas supply if the boiler is damaged. Have your installer or plumber show you the location of the gas shut off valve and demonstrate how to close the valve. If the boiler is damaged as a result of overheating, fire, flood, or any other reason, close the manual shut off valve and do not operate the boiler again until it has been inspected by a qualified technician.
- Do not store or use gasoline or other flammable liquids near this boiler. Doing so may result in fire or explosion.
- Do not place combustibles, such as newspapers or laundry, near the boiler or venting system. Doing so may result in a fire.
- Do not place or use hair sprays, spray paints, or any other compressed gases near the boiler or venting system, including the vent termination. Doing so may result in fire or explosion.
- Do not operate the boiler with the front cover opened. Doing so may result in fire or carbon monoxide (CO) poisoning, which may result in property damage, personal injury, or death.
- Do not operate this boiler without proper venting. Doing so may result in fire or carbon monoxide (CO) poisoning, which may result in property damage, personal injury, or death. Inspect the vent termination and air intake supply annually to ensure proper operation of the boiler. Turn off and discontinue use of the boiler if any of the vent pipes, vent elbows, or intake pipes are damaged in any way, separated at a joint, or show evidence of corrosion, rusting, or melting.
- Do not touch the power cord or internal components of the boiler with wet hands. Doing so may result in electric shock.
- Do not make any electrical connections before turning off the electrical power supply at service entrance panel. Doing so may result in severe personal injury or death.

CAUTION

- Do not attempt to repair or replace any part of the boiler, unless it is specifically recommended in this manual. For all other service, contact an authorized technician or licensed professional. Improper adjustments, alterations, service, or maintenance may lead to property damage, personal injury, or death and will void your warranty.
- Do not operate the boiler if you feel something is wrong with it. Doing so may result in product damage or personal injury.
- Do not allow children to operate or access the boiler. Doing so may result in product damage or personal injury.
- Do not attempt to change the DHW water temperature while the boiler is being used. Doing so may result in personal injury.
- Do not turn on the boiler unless the water and gas supplies are fully opened. Doing so may damage the boiler.
- Do not turn on the water if the cold water supply shut-off valve is closed. Doing so may damage the boiler.
- Do not use this boiler for anything other than its intended purpose, as described in this manual.
- Do not remove the front cover unless the power to the boiler is turned off or disconnected. Failure to do so may result in electric shock.
- When servicing the controls, label all wires prior to disconnecting them. Failure to do so may result in wiring errors, which can lead to improper or dangerous operation.
- Do not use unapproved replacement or accessory parts. Doing so may result in improper or dangerous operation and will void the manufacturer's warranty.
- Do not place anything in or around the vent terminals, such as a clothes line, that could obstruct the air flow in or out of the boiler.
- This boiler has been approved for use in the USA and Canada only. Using the boiler in any other country will void the manufacturer's warranty.
- Should overheating occur or the gas supply fail to shut off, turn off the manual gas valve to the appliance.

DANGER



Les vapeurs des liquides inflammables exposent, s'enflammeront et entraîneront la mort ou des brûlures graves.
Ne pas utiliser ni stocker des produits inflammables, comme de l'essence, des solvants ou des adhésifs, dans la même pièce que le Chaudière, ni près de celui-ci.

<p>Garder les produits inflammables:</p> <ol style="list-style-type: none"> Très loin du Chaudière Dans des récipients approuvés Dans des récipients fermés hermétiquement Hors de la portée des enfants. 	<p>Les vapeurs:</p> <ol style="list-style-type: none"> Sont invisibles Sont plus lourdes que l'air se propagent sur le plancher sur une grande distance peuvent être transportés à partir d'autres pièces, jusqu'à/à flammes de vapeurs, par les courants d'air
---	---

DANGER



L'eau à une température supérieure à 125°F peut instantanément causer des brûlures graves ou entraîner la mort.
Le risque de brûlures est plus élevé chez les enfants, les personnes handicapées et les personnes âgées.
Lisez la notice d'instruction avant de régler la température du Chaudière.
Vérifier la température de l'eau avant de prendre un bain ou une douche.
Des robinets limiteurs de température sont disponibles. Consultez la notice.

Une vanne de décharge de pression et de température répertoriée, conformément aux normes relatives aux vannes de décharge et aux dispositifs d'arrêt automatique de gaz pour le système d'alimentation en eau ANSI Z21.22, doit être installée lors de l'installation du Chaudière, à un emplacement spécifié par le fabricant. L'installation des dispositifs de décharge doit respecter les règlements locaux afin de garantir un fonctionnement sécurisé du Chaudière. La vanne de décharge ne doit être ni déplacée ni bouchée.

DANGER



Vapors from flammable liquids explode and catch fire causing death or severe burns.
Do not use or store flammable products such as gasoline, solvents or adhesives in the same room or area near the boiler.

<p>keep flammable products:</p> <ol style="list-style-type: none"> Far away from boiler. In approved containers. Tightly closed Out of children's reach 	<p>Vapors:</p> <ol style="list-style-type: none"> Cannot be seen Vapors are heavier than air Go a long way on the floor Can be carried from other rooms to the main burner by air currents.
---	---

DANGER



The boiler's water temperature over 125°F can cause severe burns instantly or death from scalding.
Children, disabled and elderly are at the highest risk of being scalded.
Feed water temperature before bathing or showering.
Temperature limiting valves are available, ask professional person.

WARNING: California proposition 65 lists chemical substances known to the state to cause cancer, birth defects, death, serious illness or other reproductive harm. This product may contain such substances, be their origin from fuel combustion (gas, oil) or components of the product itself.

A temperature and pressure relief valve listed as complying with the standard for Relief Valve and Automatic Gas Shutoff Devices for Hot Water Supply Systems, ANSI Z21.22, shall be installed at the time of installation of the heater in the location specified by the manufacturer. Local codes shall govern the installation of relief devices for safety operation of the boiler. The relief valve must not be removed or plugged.

FOR YOUR SAFETY READ BEFORE OPERATING

WARNING: If you do not follow these instructions exactly, a fire or explosion may result causing property damage, personal injury or loss of life.

A. This appliance does not have a pilot. It is equipped with an ignition device which automatically lights the burner. Do not try to light the burner by hand.
B. BEFORE OPERATING smell all around the appliance area for gas. Be sure to smell next to the floor because some gas is heavier than air and will settle on the floor.

WHAT TO DO IF YOU SMELL GAS

- Do not try to light any appliance
- Do not touch any electric switch; do not use any phone in your building.
- Immediately call your gas supplier from a neighbor's phone. Follow the gas supplier's instructions.
- If you cannot reach your gas supplier, call the fire department.

C. Use only your hand to turn the gas valve knob. Never use tools. If the knob will not turn by hand, don't try to repair it. Call a qualified service technician. Force or attempted repair may result in a fire or explosion.

D. Do not use this boiler if any part has been under water. Immediately call a qualified service technician to inspect the water heater and to replace any damaged parts.

OPERATING INSTRUCTIONS

- STOPI Read the safety information above.
- Set the thermostat to lowest setting.
- Turn off all electric power to the appliance.
- This appliance is equipped with an ignition device which automatically lights the burner. Do not try to light the burner by hand.
- Remove front cover.
- Turn the gas valve to "off". Handle will be across the piping; do not force.
- Wait five (5) minutes to clear out any gas. If you then smell gas, STOP! Follow "B" in the safety information above on this label. If you don't smell gas, go to the next step.
- Turn the gas valve to "on". Handle will be in line with piping.
- Install Front cover.
- Turn on all electric power to the appliance.
- Set the thermostat to desired setting.
- If the appliance will not operate, follow the instructions "To Turn Off Gas To Appliance" and call your service technician or gas supplier.

TO TURN OFF GAS TO APPLIANCE

- Set the thermostat to lowest setting.
- Turn off all electric power to the appliance if service is to be performed.
- Remove Front cover.
- Turn gas shutoff valve "off". Handle will be across the piping. Do not force.
- Install Front cover.

2. About the Boiler

2.1 Names of Components

- It is convenient to know names of components.
VC 100 COMBI

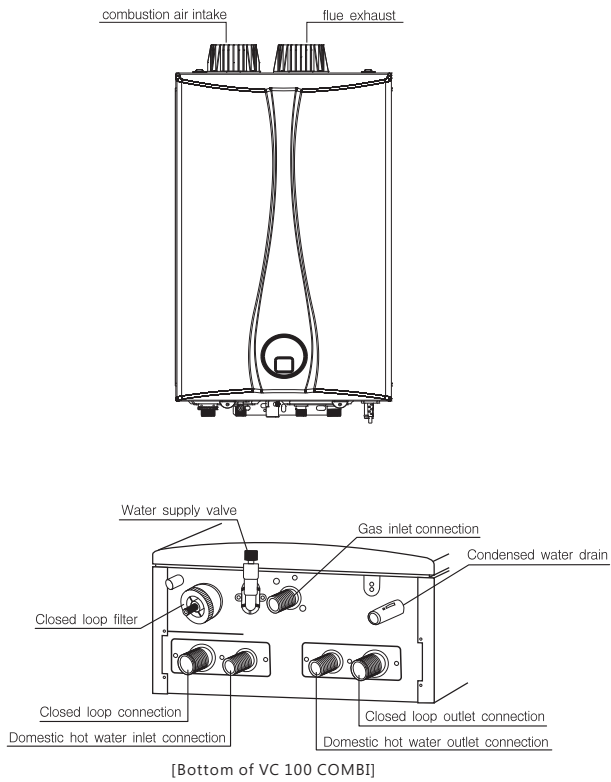

- It is convenient to know names of components.
VC 120, 140 COMBI

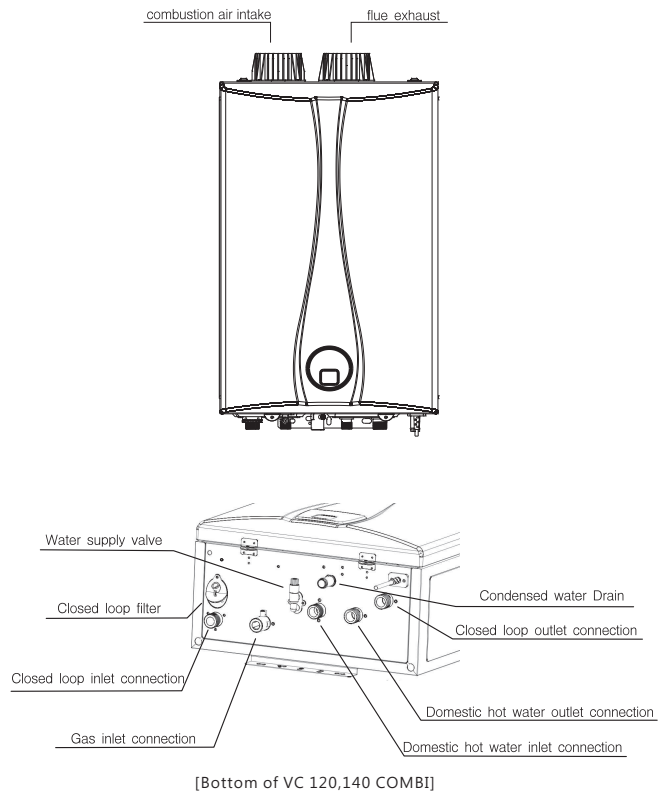

2.2 The Front Panel





The front panel allows you to adjust the temperature and view the operating status or error codes. Remove the protective sheet from the front panel before using it.

2.2.1 Icons and Digital Display



The icons and digital display on the front panel provide important information required for the boiler's operation. Refer to the following table for detailed information.



2.2.1.1 Lamp display

	Operating in CH / DHW mode
	Operation in DHW mode
TIMER	Repeat operation mode
RPM	FAN revolutions per minute (RPM)
	Flame on
OUT	DHW Outlet Temperature display
	Diagnostics display

2.2.1.2 Buttons

	Turn ON / OFF
MODE	Change the Mode Button
	Up Button
	Down Button

3. Operating the Boiler

3.1 Turning the Boiler On or Off

1. To turn the boiler on or off, press the Power button

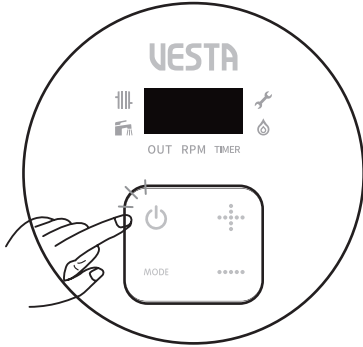

When power is ON, the boiler appear the '||||' mode and CH Temperature. If the boiler is not operating for 30 seconds, "A6" Error will appear I on the Front panel.

2. Press the + (Up) or – (Down) buttons until the desired temperature appears on the display.

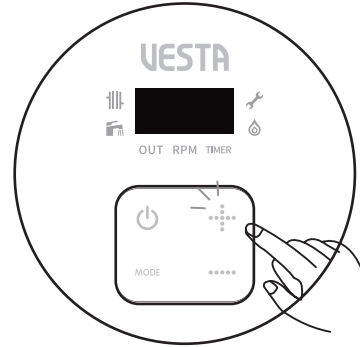

You can adjust the temperature while the display is blink for 5 seconds. Once the display stops flashing, the temperature setting is stored.

If don't press the + (Up) or – (Down) buttons, appear the setting temperature value after blank for 5 seconds.

3.2 Adjusting the CH(Space Heating) Temperature

3.2.1 Adjusting the Space Heating Temperature

To adjust the heating temperature:

1. Press the Mode button once. The '||||' (space heating display) is blink for 5 seconds and appear the space Heating outlet temperature.



Temperature range	Adjusting the water temperature
86 °F, 120-180 °F (Fahrenheit mode) 30 °C, 50-80 °C (Celsius mode)	2 °F or 1 °C increments

3.2.2 Adjusting the DHW (Domestic Hot Water) Temperature

WARNING

Before adjusting the water temperature, read “To prevent burns:” on page 6 carefully. Water above 120 °F(52 °C) can cause instant scalding, severe burns, or death.

To adjust the water temperature:

1. Press the Mode button. The ‘’ (DHW display) is blink for 5 seconds and appear the DHW temperature.

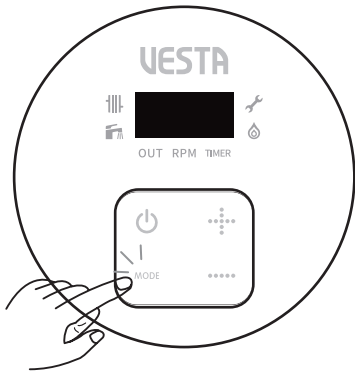

2. Press + (Up) or – (Down) buttons until the desired temperature appears on the display.

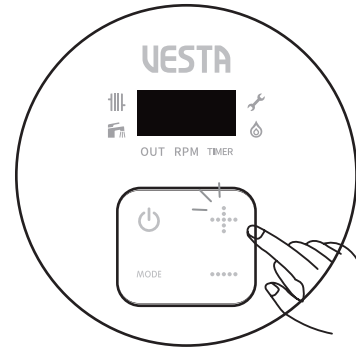

You can adjust the temperature while the display is blink for 5 seconds. Once the display stops flashing, the temperature setting is stored.

If don't press the + (Up) or – (Down) buttons, appear the setting temperature value after blank for 5 seconds.

Temperature range	Adjusting the water temperature
98-120 °F (Fahrenheit mode) 37-49 °C (Celsius mode)	2 °F or 1 °C increments
120-140 °F (Fahrenheit mode) 49-60 °C (Celsius mode)	Press for 2 seconds to adjust in 5 °F or 2 °C increments

4. Maintaining the Boiler

4.1 How to clean the hot water filter

- If install the unit first time or use for long time, rooms are not as well heated as before even can hear strange noise due to dirt in pipe and it cause shorten the use life
- Please remove the dirt when use first time in winter and more than twice in a year



CAUTION

Please unplug the unit from the power source when you clean
 - When clean with water or wet towel, it may cause electric shock
 Please follow the below when you clean the heating filter
 - When clean the heating filter, hot water in the appliance may cause burns

1. Please unplug the unit from the power source.

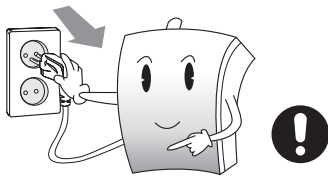

2. Please close the gas shut-off valve.

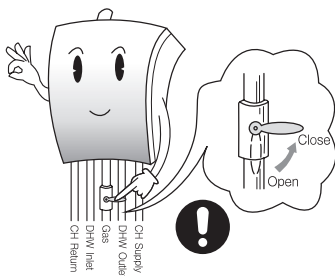

3. Please close the domestic hot water inlet valve

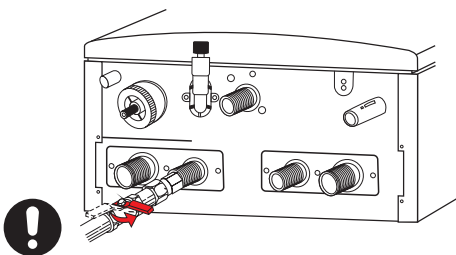

4. ① Please unfasten DHW outlet nut.
 ② Please take out the filter from DHW nipple attached the unit.

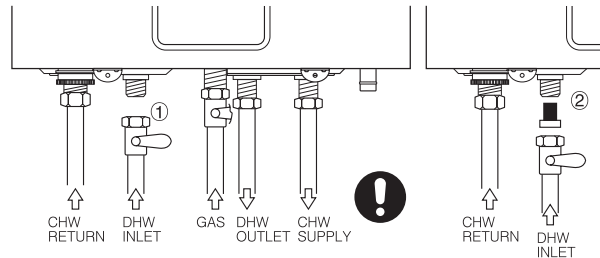

5. Please clean the domestic hot water filter with clean water.
6. After cleaning the domestic hot water filter, please reattach it in reverse order item 4.
7. Please open the domestic hot water inlet valve.

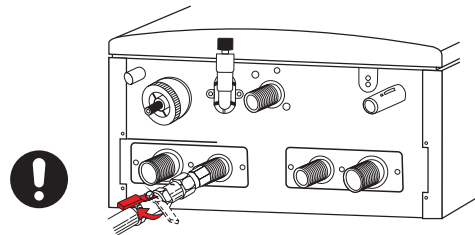

8. Please plug the unit to the power supply.
9. Please open the gas shut-off valve.

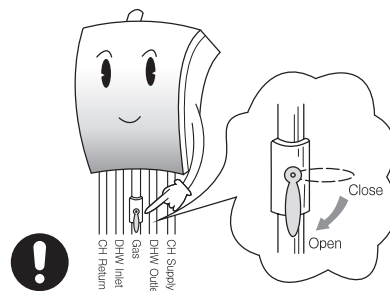

4.2 How to clean the heating filter

1. Please unplug the unit from the power source.

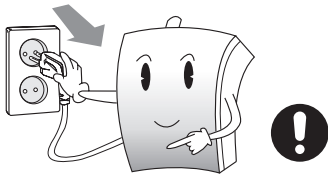

2. Please close the gas shut-off valve.

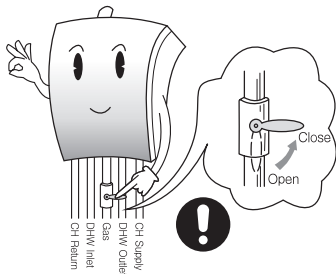

3. Please close the domestic hot water inlet valve

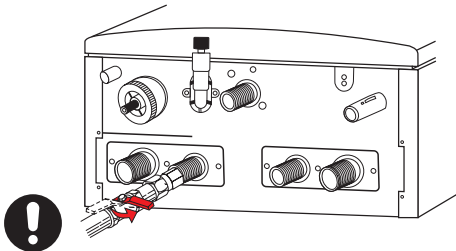

4. Please drain the water about 1.32 gal in the appliance by turning the drain valve to the left

CAUTION

When you running out the hot water, be careful not to burn yourself since there may be hot water

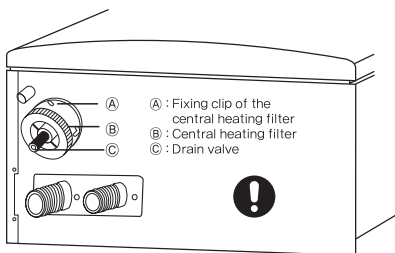

5. Please detach the fixing clip of the filter (A) by using tool.

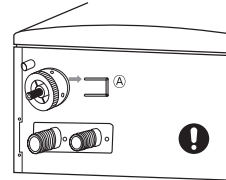

6. Please separate a heating filter.
(Please pull down the heating filter)

CAUTION

When you running out the hot water, be careful not to burn yourself since there may be hot water

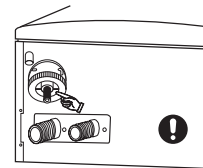

7. Please clean the heating filter with clean water.
8. After cleaning, please reattach the heating filter.
 - ① Reinsert the heating filter.
 - ② Reinsert the fixing clip of the heating filter.
 - ③ Please insert the drain screw valve by turning to the right.

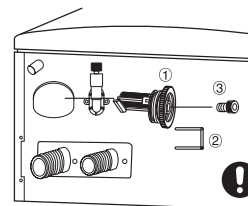

9. Please open the domestic hot water inlet valve.

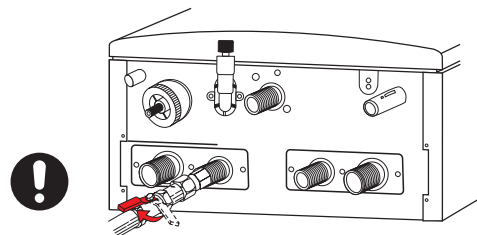

10. Please unplug the unit from the power source.

11. Please open the gas shut-off valve then please refill the water by method of refilling water.

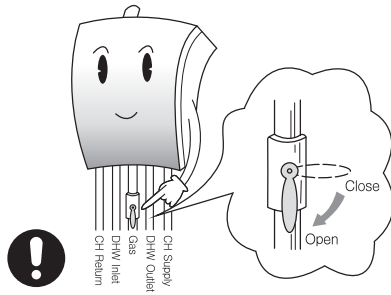

4.3 How to supply the water

- When the temperature control indicator lamp is on or "A" mark, the power lamp is red, heating loop does not have enough water to operate. Please fill the loop by opening ⑤ water supply valve and install auto feeder to heating loop. (Normal operation pressure of closed loop : 12~18psi)

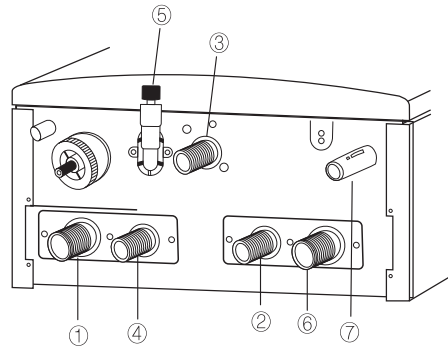

- ① Heating inlet connection
- ② Domestic hot water outlet connection
- ③ Gas inlet connection
- ④ Domestic hot water inlet connection
- ⑤ Water supplement valve
- ⑥ Heating outlet connection
- ⑦ Condensed water drain

4.4 Maintenance Schedules

Owner maintenance	
Daily	<ul style="list-style-type: none"> • Check boiler area • Check pressure / temperature gauge
Monthly	<ul style="list-style-type: none"> • Check vent piping • Check air piping (if installed) • Check air and vent termination screens • Check relief valve • Check condensate drain • Check air vents
Periodically	<ul style="list-style-type: none"> • Test low water cutoff (if used) • Reset button (low water cutoff)
Every 6 months	<ul style="list-style-type: none"> • Check boiler piping (gas and water) for leaks • Operate relief valve
End of season months	<ul style="list-style-type: none"> • Shut boiler down (unless boiler is used for domestic hot water)

Service technician (See the following instructions)	
Annual Start-up	<p>General:</p> <ul style="list-style-type: none"> • Address reported problems • Inspect interior; clean and vacuum if necessary • Clean condensate trap and fill with fresh water • Check for leaks (water, gas, flue, condensate) • Verify flue and air lines in good condition and sealed tight • Check system water pressure/system piping/expansion tank • Check control settings • Check ignition and flame rod (clean and reposition) • Check wiring and connections • Flame inspection (stable, uniform) • Flame signal <p>If combustion or performance indicate need:</p> <ul style="list-style-type: none"> • Flush heat exchanger • Remove and clean air intake filter. • Remove and clean space heating strainer. • Remove and clean inlet water filter.



WARNING

- Follow the service and maintenance procedures given throughout this manual and in component literature shipped with the boiler. Failure to perform the service and maintenance could result in damage to the boiler or system.
- Failure to follow the directions in this manual and component literature could result in severe personal injury, death, or substantial property damage.
- The boiler should be inspected annually only by a qualified service technician. In addition, the maintenance and care of the boiler must be performed to assure maximum boiler efficiency and reliability. Failure to service and maintain the boiler and system could result in equipment failure.
- Electrical shock hazard – Turn off power to the boiler before any service operation on the boiler except as noted otherwise in this instruction manual. Failure to turn off electrical power could result in electrical shock, causing severe personal injury or death.

Addressing the Reported Problems

- Inspect any problems reported by the owner and correct before proceeding.

Inspecting the Installation Area

1. Verify that boiler area is free of any combustible materials, gasoline and other flammable vapors and liquids.
2. Verify that air intake area is free of any of the contaminants listed in Installation Manual. If any of these are present in the boiler intake air vicinity, they must be removed. If they cannot be removed, reinstall the air and vent lines per the Installation Manual.

Inspecting the Boiler Interior

1. Remove the front cover and inspect the interior of the boiler.
2. Vacuum any sediment from inside the boiler and components. Remove any obstructions.

5. Troubleshooting

5.1 Checkpoints before making repair work order

- In case of malfunction, please check the following items then please call an A/S center or dealer for repairs.
 - ※When the accidents happened in case that is served, repaired, changed, installed and moved in unrelated place with manufacture , manufacture is not responsible of this.
- After has service, please check service payment and changed part. Then please sign on service register and keep this copy.

Conditions	Cause	Countermeasure
When smelled gas. (Similar to rotten onion)	<ul style="list-style-type: none"> · Please close shut-off gas valve then open all window for ventilation, and please contact gas supplier or our company service center. ※Never allowed to use combustibles or flammable material such as plug, inside light switch, match and lighter. · Please check for gas leak on the gas connection portion frequently with soapy water 	
When smelled the exhaust. (When feel dizzy and nausea)	· If the exhaust fumes leaks into the house, carbon monoxide(CO) may cause poisoning(suffocation)	
	1. Chimney is unconnected?	Please check the chimney connection.
	2. Chimney is blocked?	Please clean the chimney.
	3. Heating and supply pipe are blocked?	Please check heating and supply pipe are opened.
When the ignition spark is not working.	4. No water supply in condensed water trap?(Please check the air is circulate while operating)	Please call for inspection at A/S center.
	1. The power cord is connected?	Please plug the power cord.
	2. Gas is supplying normally?	Please open gas shut-off valve. If there is no gas in case of LPG, please exchange to new one.
When hear strange sound during operation.	3. Setting water temperature is low?	Please set water temperature higher than water temperature of the pipe
	1. Air is left in the pipe?	Please open a hand air vent and let the air out in the heating pipe.
Room is not warm enough.	2. Shut-off valve in the pipe is closed (including distributor)?	Please open shut-off valve.
	3. The appliance is attached properly on the wall?	Please fix the appliance on the wall. ※After this measure you still hear large noise, please call for inspection.
	1. The indicator is set to domestic hot water only?	Please set the indicator to central heating mode.
	2. Setting central heating water temperature is too low?	Please adjust central heating water temperature properly.
	3. Distributor valve is closed?	Open the distributor valve.
	4. Distributor valve is opened properly according to each room size?	Please check each room distributor valve is opened.
Domestic hot water is not available.	5. Central heating filter is blocked?	Clean the filter.(Please refer 11 page)
	6. Let the air out in the pipe?	Please open air vent valve in the distributor and let the air gone.
Domestic hot water is not available.	1. Domestic hot water valve is closed?	Please open domestic hot water valve.
	2. Domestic hot water filter is blocked.	Clean the filter.(Please refer 10 page)

5.2 Displayed error code

- If the unit experience to failure, the power lamp will be blinking(red) and display the following error code

No.	Error Code	Error contents
1	A2	Fan motor problem
2	A3	Pump detection switch "made"
3	A4	overheated Thermostat open
4	A5	Pump detection switch open
5	A6	Failure of ignition
6	A7	Gas valve relay stuck
7	A8	Abnormality of flame detection
8	A9	Operation for freeze prevention
9	AA	Prevention of boiling
10	Ab	Heating Temp. Thermostat Abnormality
11	Ac	DHW Temp. Thermostat Abnormality
12	Ad	Blockage of condensate
13	AE	Blockage of Flue system

LIMITED PARTS WARRANTY

The combi boiler 'VC' SERIES – RESIDENTIAL USE ONLY

Limited Parts Warranty

Subject to the terms and conditions specified herein, VESTA warrants to the original purchaser that the parts in its VC the combi boiler units ("VC Units") are free from defects in materials and workmanship for Five (5) years from the date of installation. If any parts are determined to be defective, VESTA will provide free replacement parts during the warranty period. The cost and expenses of labor for replacing such defective parts shall be borne by, and the responsibility of, the customer.

Extended Warranty Period for Heat Exchangers

VESTA warrants to the original purchaser that the primary and wet recuperative heat exchanger(s) ("Heat Exchangers") in the VC Units are free from defects in material and workmanship for Twelve (12) years from the date of installation. If any Heat Exchangers are determined to be defective, VESTA will provide free replacement parts during the warranty period. The cost and expenses of labor for replacing such defective Heat Exchangers shall be borne by, and the responsibility of, the customer. The warranty period for the plate Heat Exchanger used for domestic hot water production shall be subject to Five (5) years instead of the extended warranty period applicable to other Heat Exchangers.

The warranty period for parts (including Heat Exchangers) shall be reduced to three (3) years from date of installation if VC Unit is used in a hot water circulation system with circulation pump control, whether or not all circulating water flows through the VC Unit and/or storage tank applications.

This Limited Warranty Does Not Cover: Any coagulation or blockage in the Heat Exchanger (whether plate or otherwise) caused by trapped sediment, heavy calcification, lime deposits minerals and/or other waterborne buildup. Such coagulation, blockage, and/or buildup shall not be considered to be *defects in material or workmanship*. Therefore any malfunction or damage resulting from such causes is not covered by this limited warranty. Further this limited warranty shall NOT cover:

1. Commercial use of VC Unit. Or use of the unit as a pool-heater or spar-heater, or any use other than VC unit's specified purpose.
2. Installations by other than qualified contractors.
3. Installations and use of unit for purposes other than those specified by the instructions supplied with this VC Unit.
4. Any unit which is improperly installed or moved from its original place of installation.
5. Any unit which has been repaired or replaced with other than parts supplied by VESTA.
6. Any unit modified in any way, misused or damaged or which has been used contrary to our written instructions. Any product installed in an improper environment (e.g. corrosive, dusty, chemically contaminated, excessive lint, and etc.)
7. Any damages due to misapplication, incorrect sizing, accidents, abuse or improper installation.
8. Any damage to the unit caused by failure to maintain the unit properly, improper voltage, electrical surge, contaminated fuel, improper water pressure and/or quality, flooding, freezing, fire, lightning, or Acts of God.
9. Any damage caused by operating unit when it is not supplied with potable water at all times.
10. Any damage caused by introducing pool water, spa water, or any chemically treated water into unit.
11. Freeze damage that occurs due to failure to take proper preventive measures as described in the installation manual.

12. Condensate damage due to improperly installed or lack of a condensate trap (drain).
13. Any unit not installed in compliance with all applicable local & provincial codes, ordinances, and good trade practices.
14. Nicks, scratches or discoloration of decorative finishes.
15. Gas: incorrect gas pipe sizing, incorrect gas meter sizing, incorrect gas type, and/or gas pressures that fall outside the unit's specified range.
16. Water: incorrect water pipe sizing, water pressures that fall outside the unit's specified range, recirculation flow rates that fall outside the unit's specified range and/or lack of proper air removal in a closed-loop circulation system.
17. Damages caused by supply of power voltages that fall outside the unit's specified range.
18. Any failures caused by improper plumbing, gas piping and wiring while installing the unit.
19. Any failures from sediment, rust, corrosion, etc. introduced from outside the unit.
20. Any failures due to defects in materials or workmanship (mechanical and/or electrical parts) that are not part of VC Unit.
21. Any unauthorized alterations, attachments, or repairs to the unit.
22. Any damage resulting from use of non-approved anti-freeze solution added to the heating water.
23. Units purchased from unauthorized Internet retailers including vendors on auction sites such as Ebay.

This limited warranty does not cover any cost or expenses related to the removal of defective parts and/or installation of replacement parts, including cost of all labor and material connected therewith (other than the replacement parts), and transportation to and from VESTA.

The limited warranty does not provide any warranty for the workmanship of an installer connected with the installation of VC Unit, or shall not be construed as imposing a liability of any nature for unsatisfactory performance by such installer, which liability is expressly disclaimed.

Exclusion and Limitation of Damages

VESTA shall not be liable for any special, incidental, indirect or consequential damages that may arise in connection with the defects in VC Unit or its parts.

The maximum liability of VESTA in connection with this limited warranty shall not in any case exceed the price of the part determined to be defective, or the price of the unit if the entire unit is determined to be defective.

Such "special," "incidental," "indirect" or "consequential" damages excluded from this limited warranty include, without limitation, injury to persons or property, loss of use, failure to install drain pan, expenses of inspection, obtaining substitute goods, transportation, etc.

Owner's Responsibilities

This warranty is issued to the original purchaser only. This product must be used and cared for in accordance with the instruction manual. You are responsible for required periodic maintenance or service such as lubrication, cleaning the strainer, and cleaning the components. See your instruction manual for details. You must be able to verify the installation date of the product against which you make any warranty claim. The original bill of sale, installer's invoice or other similar document is required to verify the warranty. If you cannot show evidence of the actual date of installation, warranty coverage will be considered to start on the date the product is shipped from our distributor.

The attached warranty card must be filled out completely and returned to VESTA. Failure to do so will prevent or delay our being able to contact you (or the person residing at this address) in case of a recall or important product safety alert.

Your warranty information will be held strictly confidential

WARRANTY & PRODUCT REGISTRATION CARD

Register your combi boiler

Thank you for purchasing VESTA combi boiler product.

Filling out this form will help you obtain more efficient warranty service in case there is a problem with your product and also allow us to update you of any warranty and/or safety notice regarding your unit.

Fill out this form and mail it to the address at the bottom for your benefits.

Date of Purchase:

Date of Installation:

Purchased from:

Model No.:

Serial No.:

Date of Installation:

Installer Information

Installed by:

Installer's License No.:

Address:

Phone:

Home Owner Info

Name:

Address of installation:

Phone:

VESTA Warranty Department

User's Manual

Condensing Combi-Boilers

Version : 1.0 (May 30, 2016)

Getting Service

If your boiler requires service, you have several options for getting service:

- Contact Technical Support at 1-800-761-0053 or on the website: www.vestahws.com
- For warranty service, always contact Technical Support first.
- Contact the technician or professional who installed your boiler.
- Contact a licensed professional for the affected system (for example, a plumber or electrician).

When you contact Technical Support, please have the following information at hand:

- Model number
- Serial number
- Date purchased
- Installation location and type
- Error code, if any appears on the front panel display